

Mechanical In-Line Splice
With Moisture/Contaminant
Block for Medium/High
Voltage Applications

MECHANICAL CONNECTORS

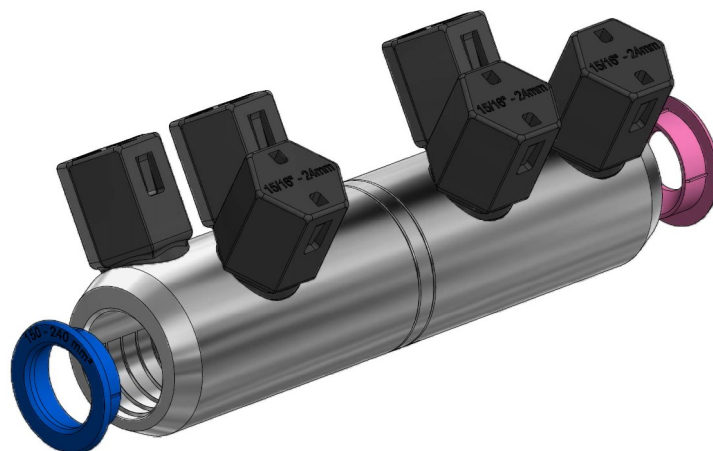





'EUMF/NC' Connectors



Principle Application:

Straight jointing of circular stranded aluminium or copper conductors for all cable voltages up to and including 42kV.

Range:

Connector Reference	Internal Bore (mm ²)	Cable Range (mm ²)						Cable Centralising Rings(s)	
									
		Stranded Circular (mm ²)	Solid Circular (mm ²)	Solid Sector 3 core (mm ²)	Solid Sector 4 core (mm ²)	Stranded Sector	Compacted Circular	Colour	Range (mm ²)
EUMF0	13	16-95 (#6-3/0)	16-95	50	50-70	35-75	16-95	White x 2 Green x 2	16-25 35-50
EUMF1	16	35-150 (#2-300 kcmil)	35-150	25-95	25-95	50-120	35-150	Orange x 2 Purple x 2	35-50 70-95
EUMF2	21	50-2 (1 AWG-500kcmil)	50-240	50-150	50-185	50-240	50-240	Yellow x 2 Red x 2	50-95 120-150
EUMF2.5	26	95-400 (3/0-750 kcmil)	95-400	185-240	185-300	185-240	95-400	Pink x 2 Blue x 2	95-120 150-240
EUMF3	30	240-500 (450-900 kcmil)	240-500	-300	-	240-300	240-500	Brown x 2	240-300
EUMF8	34	400-630 (800-1250 kcmil)	400-630	-	-	300-400	400-630	-	-
EUMF9	43	800-1000 (1550-1950 kcmil)	800-1000	-	-	-	800-1000	-	-

The 'EUMF/NC' range of mechanical connectors incorporate an integral moisture/contaminant block and uses the Sicame MK2 universal range taking shear bolts.

Mechanical In-Line Splice
With Moisture/Contaminant
Block for Medium/High
Voltage Applications

MECHANICAL CONNECTORS

'EUMF/NC' Aluminium In-Line Splices

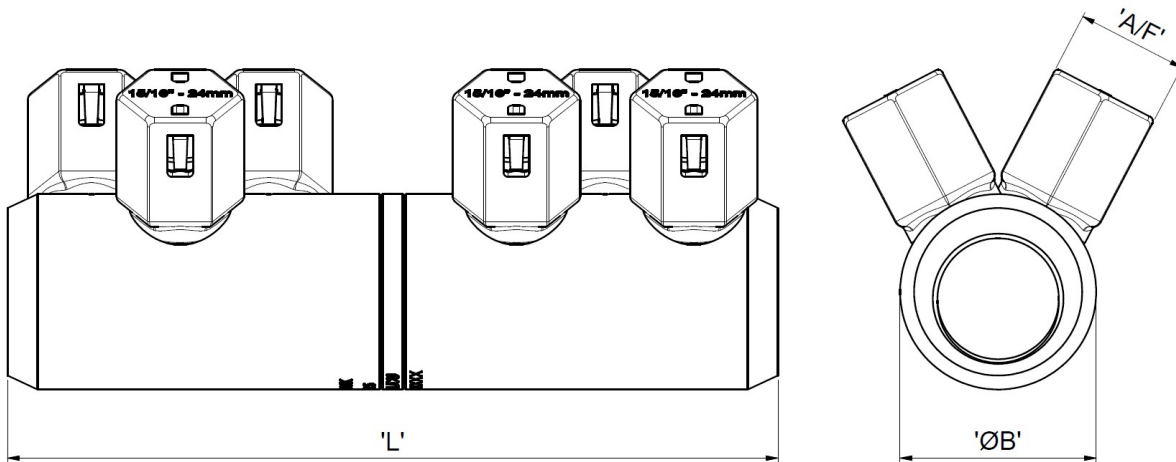

Connector Reference	Dimensions (in /mm)		
	'L'	'ØB'	'AF'
EUMF0	2.36" (60mm)	1.18" (30mm)	3/4" (19mm)
EUMF1	3.34" (85mm)	1.10" (28mm)	3/4" (19mm)
EUMF2	4.92" (125mm)	1.33" (34mm)	15/16" (24mm)
EUMF2.5	6.49" (165mm)	1.65" (42mm)	15/16" (24mm)
EUMF3	6.88" (175mm)	1.85" (47mm)	15/16" (24mm)
EUMF8	6.88" (175mm)	2.00" (51mm)	15/16" (24mm)
EUMF9	7.44" (189mm)	2.48" (63mm)	15/16" (24mm)

Material: Aluminium Alloy (Electro-Tinned)

Test Specification: BS EN 61238-Class A

Test Report No: TTR/345

Fitting instructions:

1. Strip insulation from each core equal to the depth of the bore.
2. Wire brush the exposed conductor cores and wipe clean (optional).
3. Fit the appropriate sized cable centering ring (if required).
4. Align and position the conductor cores in each of the bores ensuring that the core is fully inserted to the center wall.
5. Fit the universal shear screws within the connector and torque tighten one turn at a time, using a 3/4" or 15/16" AF socket, until the bolts have sheared.